

- SPST Switch Configuration
- 16 Relay Version Switches 5A
- Higher Density 32 & 39 Relay Versions Switch 2A
- Hot Switch to 110VDC/250VAC
- Cold Switch to 400VDC/250VAC
- 150W/1250VA Max Power For 16 Relay Version
- 90W/500VA Max Power For 32/39 Relay Versions
- VISA, IVI & Kernel Drivers Supplied for Windows
- Supported by PXI or LXI Chassis
- 3 Year Warranty



Pickering Interfaces 40-137 Power Relay Module is suitable for applications requiring power relay switching with high density. They are configured as Single Pole Single Throw (SPST) and they feature current handling up to 5A and 110VDC/250VAC voltage rating. Connections are made via a front panel mounted 37 or 78-pin D-Type connector.

Typical applications will be found in Automotive, Aerospace and Power Cell Testing applications.

Range Description:

- 40-137-001 16 SPST Power Relays.
- 40-137-101 32 SPST Power Relays.
- 40-137-201 39 SPST Power Relays.

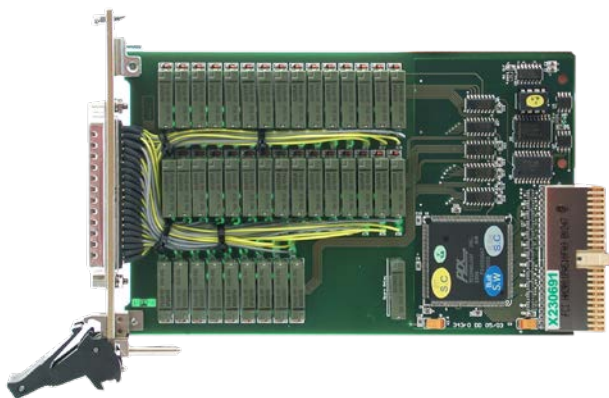

PCB View of the 40-137 High Density Power Relay Module

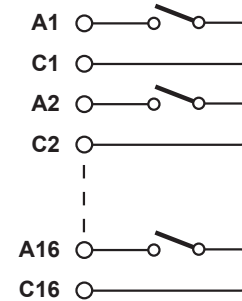

40-137-001 5A Power Relay Module - 16 x SPST

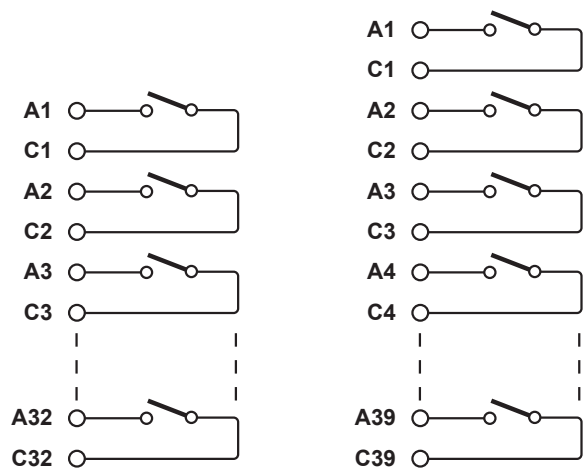

40-137-101 2A Power Relay Module - 32 x SPST

40-137-201 2A Power Relay Module - 39 x SPST

ISSUE 10.2 AUG 2019

Power Relay Type

The 40-137 is fitted with electro-mechanical power relays with gold clad silver alloy contacts. A Spare Relay is built onto the circuit board to facilitate easy maintenance with minimum downtime.

Switching Specification - 40-137-001 (16 x SPST, 5A)

Contact Type:	Gold clad silver alloy
Cold Switching Capacity	
Maximum Current:	5A
Maximum Voltage:	400VDC/250VAC*
Hot Switching Capacity	
Maximum Current:	5A
Maximum Voltage:	110VDC/250VAC*
Maximum Power:	150W/1250VA
Min. Switching Capacity:	10mA, 5VDC
Typical Pulse Capability:	Cold Switch 10A for 100ms under low duty cycle conditions (contact sales office for further advice)
Initial On Path Resistance:	<250mΩ
Off Path Resistance:	>10 ⁹ Ω
Bandwidth:	>20MHz
Operate Time:	10ms typical
Expected Life - resistive load	
Mechanical Life:	>2x10 ⁷ operations
At Max. Switch Capacity:	>5x10 ⁴ (5A 250VAC, 5A 30VDC) >1x10 ⁵ (3A 250VAC, 3A 30VDC)

* For full voltage rating, signal sources to be switched must be fully isolated from mains supply and safety earth.

Switching Specification - 40-137-101/201 (32/39 x SPST)

Contact Type:	Gold clad silver alloy
Cold Switching Capacity	
Maximum Current:	2A
Maximum Voltage:	400VDC/250VAC*
Hot Switching Capacity	
Maximum Current:	5A
Maximum Voltage:	110VDC/250VAC*
Maximum Power:†	90W/500VA
Min. Switching Capacity:	100μA, 100mVDC
Initial On Path Resistance:	<250mΩ
Off Path Resistance:	>10 ⁹ Ω
Bandwidth:	>20MHz
Operate Time:	10ms typical
Expected Life - resistive load	
Mechanical Life:	>1x10 ⁷ operations
At Max. Switch Capacity:	>1x10 ⁵ operations

* For full voltage rating, signal sources to be switched must be fully isolated from mains supply and safety earth.

† For variation of maximum hot switching capacity of voltage with current refer to plot.

Power Requirements

+3.3V	+5V	+12V	-12V
0	1.1A (typ 400mA)	0	0

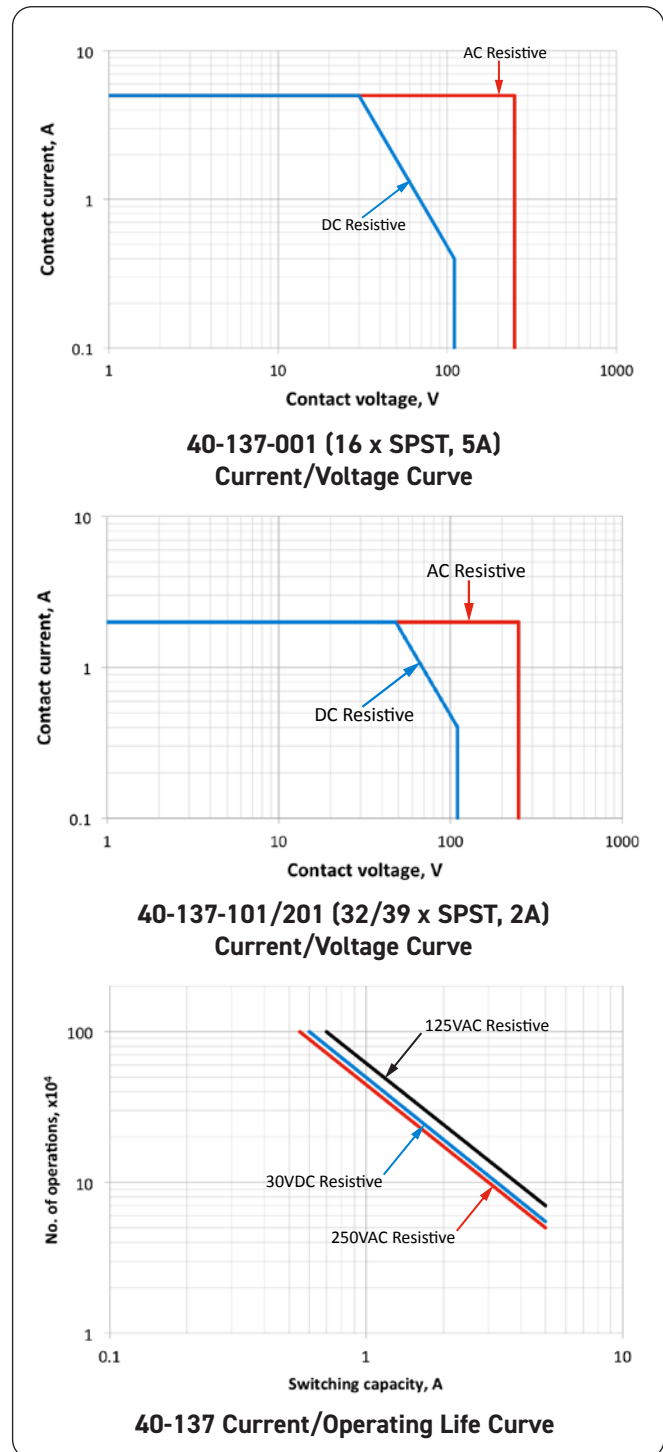

Mechanical Characteristics

Single slot 3U PXI (CompactPCI card).

Module weight: 200g (40-137-001).

3D models for all versions in a variety of popular file formats are available on request.

Connectors

PXI bus via 32-bit P1/J1 backplane connector.

Signals via front panel male D-Type connector, for pin outs please refer to the operating manual.

- 40-137-001 37-pin D-Type male connector
- 40-137-101 78-pin D-Type male connector
- 40-137-201 78-pin D-Type male connector

Operating/Storage Conditions

Operating Conditions

Operating Temperature: 0°C to +55°C
 Humidity: Up to 90% non-condensing
 Altitude: 5000m

Storage and Transport Conditions

Storage Temperature: -20°C to +75°C
 Humidity: Up to 90% non-condensing
 Altitude: 15000m

PXI & CompactPCI Compliance

The module is compliant with the PXI Specification 2.2. Local Bus, Trigger Bus and Star Trigger are not implemented.

Uses a 33MHz 32-bit backplane interface.

Safety & CE Compliance

All modules are fully CE compliant and meet applicable EU directives: Low-voltage safety EN61010-1:2010, EMC Immunity EN61326-1:2013, Emissions EN55011:2009+A1:2010.

Product Order Codes

16 x SPST, 5A Power Relay Module	40-137-001
32 x SPST, 2A Power Relay Module	40-137-101
39 x SPST, 2A Power Relay Module	40-137-201

Product Customization

Pickering PXI modules are designed and manufactured on our own flexible manufacturing lines, giving complete product control and enabling simple customization to meet very specific requirements.

Customization can include:

- Alternative relay types
- Mixture of relay types
- Alternative number of relays
- Different performance specifications

All customized products are given a unique part number, fully documented and may be ordered at any time in the future. Please contact your local sales office to discuss.

Support Products

Spare Relay Kits

Kits of replacement relays are available for the majority of Pickering's PXI switching products, simplifying servicing and reducing down-time.

Product	Relay Kit
40-137-001/101/201	91-100-020 (Kit 20)

For further assistance, please contact your local Pickering sales office.

Mating Connectors & Cabling

For connection accessories for the 40-137 series please refer to the [90-006D](#) 78-pin D-Type and [90-007D](#) 37-pin D-Type Connector Accessories data sheets where a complete list and documentation can be found for accessories, or refer to the Connection Solutions catalog.

Chassis Compatibility

This PXI module must be used in a suitable chassis. It is compatible with the following chassis types:

- All chassis conforming to the 3U PXI and 3U Compact PCI (cPCI) specification
- Legacy and Hybrid Peripheral slots in a 3U PXI Express (PXIe) chassis
- Pickering Interfaces LXI or LXI/USB Modular Chassis

Chassis Selection Guide

Standard PXI or hybrid PXIe Chassis from any Vendor:

- Mix our 1000+ PXI switching & simulation modules with any vendor's PXI instrumentation
- Embedded or remote Windows PC control
- Real-time Operating System Support
- High data bandwidths, especially with PXI Express
- Integrated module timing and synchronization

Pickering LXI or LXI/USB Modular Chassis—only accept our 1000+ PXI Switching & Simulation Modules:

- Ethernet or USB control enables remote operation
- Low-cost control from practically any controller
- LXI provides manual control via Web browsers
- Driverless software support
- Power sequencing immunity
- Ethernet provides chassis/controller voltage isolation
- Independence from Windows operating system



Connectivity Solutions

We provide a full range of supporting cable and connector solutions for all our switching products—20 connector families with 1200+ products. We offer everything from simple mating connectors to complex cables assemblies and terminal blocks. All assemblies are manufactured by Pickering and are guaranteed to mechanically and electrically mate to our modules.

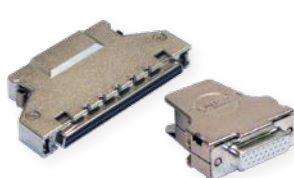

Connectors & Backshells



Multiwire Cable Assemblies

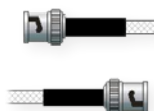

RF Cable Assemblies



Connector Blocks

We also offer customized cabling and have a free online **Cable Design Tool** that can be used to create custom cable solutions for many applications.

Visit: pickeringtest.com/cdt to start your design.

Mass Interconnect

We recommend the use of a mass interconnect solution when an Interchangeable Test Adapter (ITA) is required for a PXI or LXI based test system. Our modules are fully supported by both Virginia Panel and MacPanel.

Pickering Reed Relays

We are the only switch provider with in-house reed relay manufacturing capability via our sister company, Pickering Electronics. These instrument grade reed relays feature **SoftCenter®** technology, ensuring long service life and repeatable contact performance.

To learn more, please go to: pickeringrelay.com



Programming

Pickering provide kernel, IVI and VISA (NI & Keysight) drivers which are compatible with all Microsoft supported versions of Windows and popular older versions. For a list of all supporting operating systems, please see: pickeringtest.com/os

The VISA driver is also compatible with Real-Time Operating Systems such as LabVIEW RT. For other RTOS support contact Pickering. These drivers may be used with a variety of programming environments and applications including:

- **Pickering Interfaces Switch Path Manager**
- **National Instruments** products (LabVIEW, LabWindows/CVI, Switch Executive, MAX, TestStand, VeriStand, etc.)
- **Microsoft Visual Studio** products (Visual Basic, Visual C+)
- **Keysight** VEE and OpenTAP
- **Mathworks** Matlab
- **Marvin** ATEasy
- **MTQ Testsolutions** Tecap Test & Measurement Suite

Drivers for popular Linux distributions are available, other environments are also supported, please contact Pickering with specific enquiries. We provide Soft Front Panels (SFPs) for our products for familiarity and manual control, as well as comprehensive documentation and example programs to help you develop test routines with ease.

To learn more about software drivers and development environments, please go to:

pickeringtest.com/software

Signal Routing Software

Our signal routing software, Switch Path Manager, automatically selects and energizes switch paths through Pickering switching systems. Signal routing is performed by simply defining test system endpoints to be connected together, greatly accelerating Test System software development. To learn more, please go to: pickeringtest.com/spm



Diagnostic Relay Test Tools

eBIRST Switching System Test Tools are designed specifically for our PXI, PCI or LXI products, these tools simplify switching system fault-finding by quickly testing the system and graphically identifying the faulty relay.

To learn more, please go to: pickeringtest.com/ebirst



Three Year Warranty & Guaranteed Long-Term Support

All standard products manufactured by Pickering Interfaces are warranted against defective materials and workmanship for a period of three years from the date of delivery to the original purchaser. Extended warranty and service agreements are available for all our modules and systems with various levels to suit your requirements. Although we offer a 3-year warranty as standard, we also include guaranteed long-term support—with a history of supporting our products for typically 15-20 years. To learn more, please go to: pickeringtest.com/support

Available Product Resources

We have a large library of product resources including success stories, product and support videos, articles, as well as complete product catalogs and product reference maps to assist when looking for the switching, simulation and cable and connector solutions you need. We have also published handy reference books on Switching Technology and for the PXI and LXI standards.

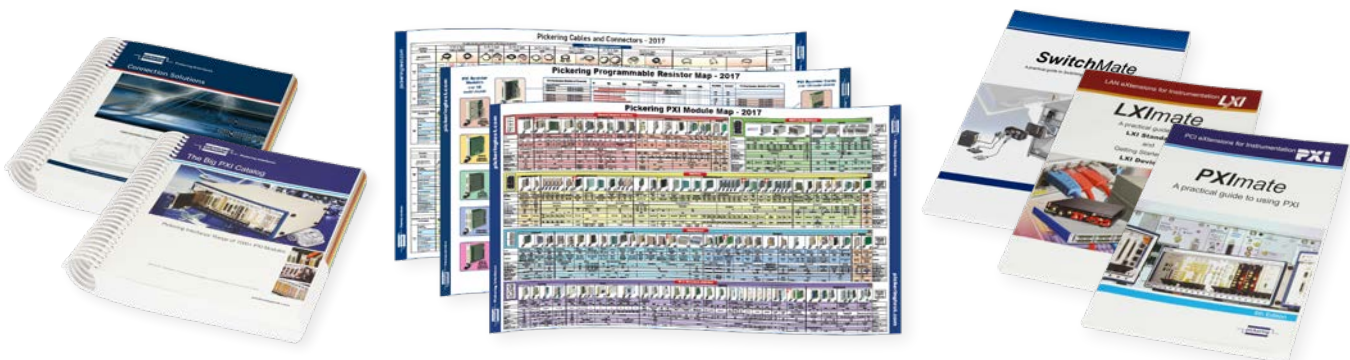

To view, download or request any of our product resources, please visit: pickeringtest.com/resources