

- Available as PXI or PXIe Modules
- Up to 50 x SPST Power Relays Per Module
- Available With Optional Hardware Interlock
- Hot Switch up to 250 VAC, 5 A
- Cold Switch up to 400 VDC/250 VAC Peak
- Maximum Power Handling 150 W/1250 VA
- VISA, IVI & Kernel Drivers Supplied for Windows
- PXI Version Supported by PXI or LXI Chassis
- 3 Year Warranty

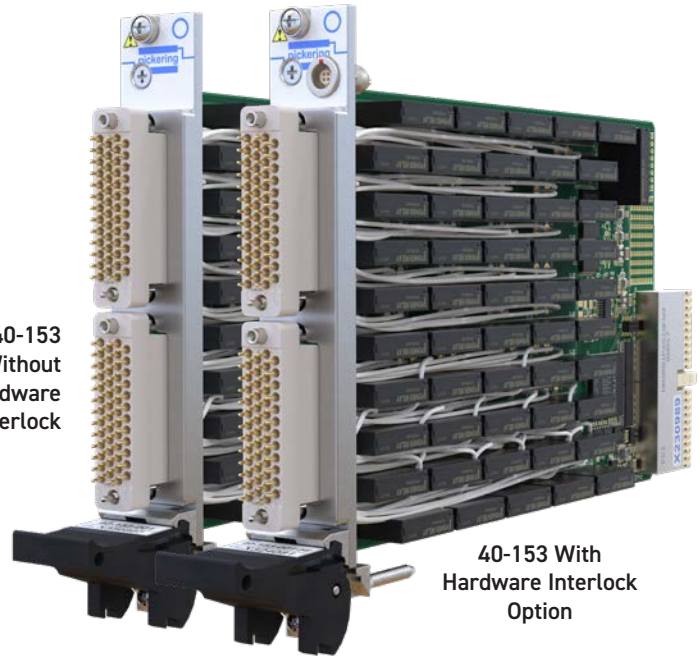

40-153 Without Hardware Interlock

40-153 With Hardware Interlock Option

Pickering's Range of PXI/PXIe High Power Switch Modules				
Model No.	Configuration	Relay Type	Max Voltage	Max Current
40-150/151	8 or 12xDPST	EMR	400 VDC, 250 VAC	5 A
40/42-153	18, 25, 36 or 50xSPST	EMR	400 VDC, 250 VAC	5 A
40-155/156	8 or 16xSPDT	EMR	400 VDC, 250 VAC	5 A
40-157	8xDPDT			
40/42-158	8, 16, 24 or 32xSPDT			
40-160	10 or 20xSPST or 10xDPST		125 VDC, 250 VAC	10 A or 8 A
40-161	10, 12, 16xSPST 6, 12xSPDT		300 VDC, 250 VAC	16 A
40/42-166	10 or 5xSPST, 6 or 3xSPDT or 3, 2 or 1xSP4T		300 VDC, 480 VAC	30 A or 20 A
40-170	2xSPST or 2xDPST		30 VDC, 250 VAC	30 A
40-180	2 or 4xSPST		14 VDC or 28 VDC	40 A or 20 A
40-181	2xSPDT			
40-182A	3 or 6xSPST		Solid State	200 VDC/AC peak
40-183B	6xSPST	40 VDC/AC peak		40 A
40-184A	3 or 6xSPST	100 VDC/AC peak		25 A
40-185A	3 or 6xSPST	400 VDC/AC peak		1.5 A

The 40-153 (PXI) and 42-153 (PXIe) power relay modules are suitable for switching either mains voltage or DC. They are available in multiple configurations up to 50 x SPST (Single Pole Single Throw) and are suitable for inductive/capacitive loads up to 5 A at 250 VAC. Power relay modules are intended for switching heavy AC or DC loads or for controlling large external relays, contactors and solenoids.

### Relay Type

The 40/42-153 is fitted with electro-mechanical power relays with gold flash over silver alloy contacts. A spare relay is built onto the circuit board to allow easy maintenance with minimum downtime.

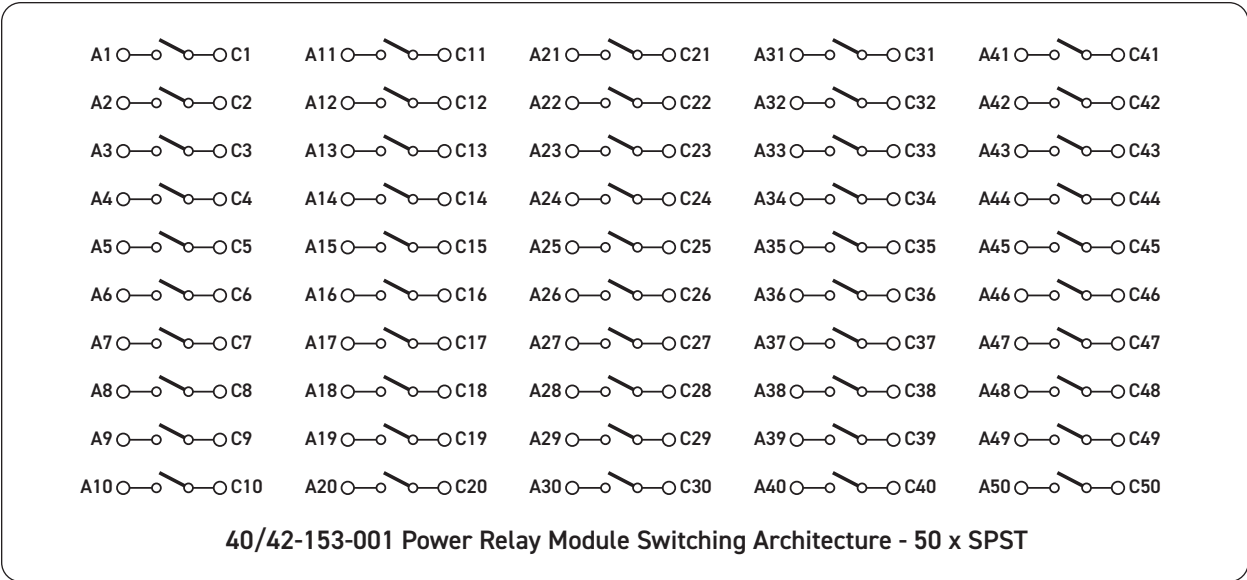

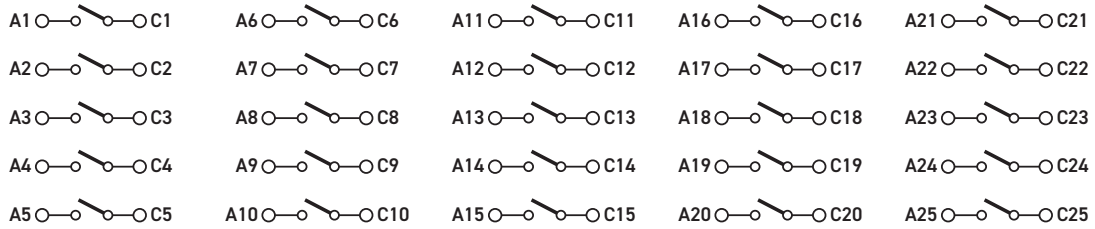

**40/42-153-003/103 Power Relay Module Switching Architecture - 25 x SPST**

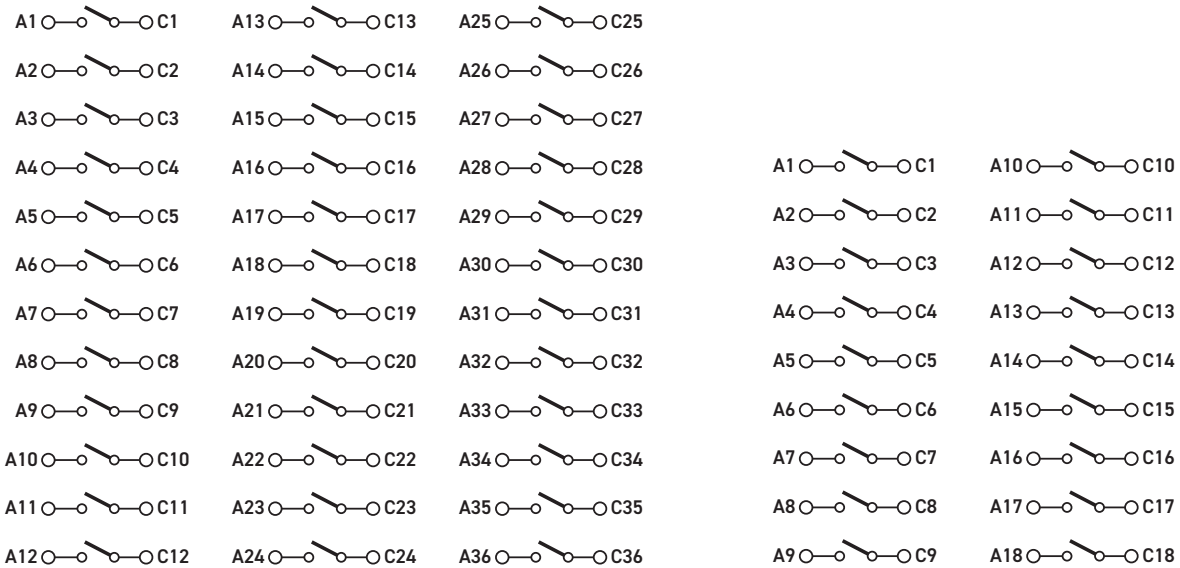

**40/42-153-002 Power Relay Module Switching Architecture - 36 x SPST**

**40/42-153-004/104 Power Relay Module Switching Architecture - 18 x SPST**

## Hardware Interlock

All versions of the 40/42-153 are available with an optional hardware interlock. The interlock, when activated, will return all relays to their default unpowered state (assuming the relays are fully functional) and also provide error notification via the software interface. The interlock feature can be daisy-chained between additional hardware interlock enabled modules for example to allow one signal to disable multiple cards. For further details please refer to the Hardware Interlock section within the user manual.

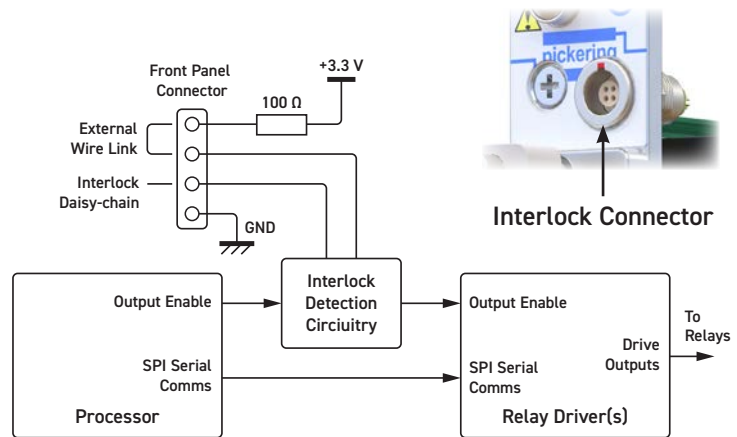

**Interlock Signal Routing Diagram for 40/42-153 Versions With Hardware Interlock Option**

## Switching Specification

Contact Type:	Gold flash over silver alloy
Cold Switching Capacity	
Maximum Current:	5 A
Maximum Voltage:	400 VDC/250 VAC*
Hot Switching Capacity	
Maximum Current:	5 A
Maximum Voltage:	110 VDC/250 VAC*
Maximum Power:†	150 W/1250 VA
Min. Switching Capacity:	10 mA, 5 VDC
Initial On Path Resistance:	<35 mΩ
Off Path Resistance:	>10 <sup>9</sup> Ω
Thermal Offset:	3 μV (typical)
Operate Time:	10 ms (typical)
Expected Life (operations) - resistive load	
Mechanical Life:	>2x10 <sup>7</sup> operations
At Max. Switch Capacity:	>5x10 <sup>4</sup> (5 A 250 VAC, 5 A 30 VDC) >1x10 <sup>5</sup> (3 A 250 VAC, 3 A 30 VDC)

\* For full voltage rating, signal sources to be switched must be fully isolated from mains supply and safety earth.

† For variation of maximum hot switching capacity of voltage with current refer to plot.

## RF Specification

Bandwidth (-3dB point):	65 MHz (typical)
Bandwidth (1.5:1 VSWR):	40 MHz (typical)
Crosstalk (typical):	10 kHz: -65 dB 100 kHz: -60 dB 1 MHz: -50 dB 10 MHz: -30 dB 65 MHz: -10 dB
Isolation (typical):	10 kHz: 60 dB 100 kHz: 55 dB 1 MHz: 50 dB 10 MHz: 35 dB 65 MHz: 15 dB

## Power Requirements - 40-153

+3.3V	+5V	+12V	-12V
150 mA	1 A	0	0

## Power Requirements - 42-153

+3.3V	+12V
150 mA	0.5 A

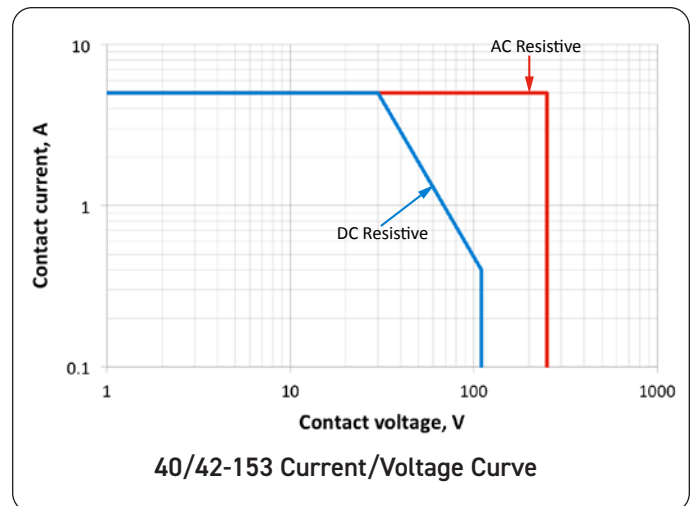

## Mechanical Characteristics

40-153 - Single slot 3 U PXI (CompactPCI card).

42-153 - Single slot 3 U PXIe, compatible with PXIe hybrid slot.

Module weight: 340 g

3D models for all versions in a variety of popular file formats are available on request.

## Connectors

40-153 - PXI bus via 32-bit P1/J1 backplane connector.

42-153 - PXIe bus via XJ3 and XJ4 backplane connectors.

Signals via front panel connectors, for pin outs please refer to the operating manual:

- 40/42-153-001/002 2 x 50-pin male SGMC connectors
- 40/42-153-003/004 1 x 50-pin male SGMC connector
- 40/42-153-103 1 x 50-pin male D-type connector
- 40/42-153-104 1 x 37-pin male D-type connector
- Interlock: 1 x 4-pin female 00 series connector\* (40/42-153 versions with hardware interlock option)

\*Mating half supplied when hardware interlock option ordered.

## PXI & CompactPCI Compliance - 40-153

The module is compliant with the PXI Specification 2.2. Local Bus, Trigger Bus & Star Trigger are not implemented. Uses a 33 MHz 32-bit backplane interface.

## PXIe Compliance - 42-153

The module is compliant with the PXIe Specification 1.0. Local Bus, Trigger Bus & Star Trigger are not implemented.

## Safety & CE Compliance

All modules are fully CE compliant and meet applicable EU directives: Low-voltage safety EN61010-1:2010, EMC Immunity EN61326-1:2013, Emissions EN55011:2009+A1:2010.

## Product Order Codes

### PXI 5 A Power Relay Module

50 x SPST (50-pin SGMC Connectors)	40-153-001
36 x SPST (50-pin SGMC Connectors)	40-153-002
25 x SPST (50-pin SGMC Connector)	40-153-003
25 x SPST (50-pin D-type Connector)	40-153-103
18 x SPST (50-pin SGMC Connector)	40-153-004
18 x SPST (37-pin D-type Connector)	40-153-104

### PXI 5 A Power Relay Module With Hardware Interlock

50 x SPST (50-pin SGMC Connectors)	40-153-001-HI
36 x SPST (50-pin SGMC Connectors)	40-153-002-HI
25 x SPST (50-pin SGMC Connector)	40-153-003-HI
25 x SPST (50-pin D-type Connector)	40-153-103-HI
18 x SPST (50-pin SGMC Connector)	40-153-004-HI
18 x SPST (37-pin D-type Connector)	40-153-104-HI

### PXIe 5 A Power Relay Module

50 x SPST (50-pin SGMC Connectors)	42-153-001
36 x SPST (50-pin SGMC Connectors)	42-153-002
25 x SPST (50-pin SGMC Connector)	42-153-003
25 x SPST (50-pin D-type Connector)	42-153-103
18 x SPST (50-pin SGMC Connector)	42-153-004
18 x SPST (37-pin D-type Connector)	42-153-104

### PXIe 5 A Power Relay Module With Hardware Interlock

50 x SPST (50-pin SGMC Connectors)	42-153-001-HI
36 x SPST (50-pin SGMC Connectors)	42-153-002-HI
25 x SPST (50-pin SGMC Connector)	42-153-003-HI
25 x SPST (50-pin D-type Connector)	42-153-103-HI
18 x SPST (50-pin SGMC Connector)	42-153-004-HI
18 x SPST (37-pin D-type Connector)	42-153-104-HI



42-153-001 PXIe 50xSPST 5 A Power Relay Module

## Product Customization

Pickering modules are designed and manufactured on our own flexible manufacturing lines, giving complete product control and enabling simple customization to meet very specific requirements.

Customization can include:

- Alternative relay types
- Mixture of relay types
- Alternative number of relays
- Different performance specifications

All customized products are given a unique part number, fully documented and may be ordered at any time in the future. Please contact your local sales office to discuss.

## Support Products

### Spare Relay Kits

Kits of replacement relays are available for the majority of Pickering's switching products, simplifying servicing and reducing down-time.

Product	Relay Kit
40/42-153-x0x	91-100-020

For further assistance, please contact your local Pickering sales office.

### Interlock Connectors

For modules with the hardware interlock option (40/42-153-x0x-HI) spare/replacement connectors can be ordered.

Product	Description
44-961-040	Connector with internal link (replacing that supplied with the module).
44-960-040	Connector only, no internal wiring.

## Mating Connectors & Cabling

For connection accessories for the 40/42-153 module please refer to the [90-027D](#) 50-pin SGMC, [90-005D](#) 50-pin D-type or [90-007D](#) 37-pin D-type Connector Accessories data sheets where a complete list and documentation can be found for accessories, or refer to the Connection Solutions catalog.

## Operating/Storage Conditions

### Operating Conditions

Operating Temperature:	0°C to +55°C
Humidity:	Up to 90% non-condensing
Altitude:	5000 m

### Storage and Transport Conditions

Storage Temperature:	-20°C to +75°C
Humidity:	Up to 90% non-condensing
Altitude:	15000 m



## Chassis Compatibility

The PXI versions of this module must be used in a suitable chassis. They are compatible with the following chassis types:

- All chassis conforming to the 3U PXI and 3U Compact PCI (cPCI) specification
- Legacy and Hybrid Peripheral slots in a 3U PXI Express (PXIe) chassis
- Pickering Interfaces LXI or LXI/USB Modular Chassis

The PXIe versions of this module are compatible with the following chassis types:

- All chassis conforming to the 3U PXIe specification
- PXIe and Hybrid Peripheral slots in a 3U PXI Express (PXIe) chassis

## Chassis Selection Guide

### Standard PXI or hybrid PXIe Chassis from any Vendor:

- Mix our 1000+ PXI switching & simulation modules with any vendor's PXI instrumentation
- Embedded or remote Windows PC control
- Real-time Operating System Support
- High data bandwidths, especially with PXI Express
- Integrated module timing and synchronization

### Pickering LXI or LXI/USB Modular Chassis—only accept our 1000+ PXI Switching & Simulation Modules:

- Ethernet or USB control enables remote operation
- Low-cost control from practically any controller
- LXI provides manual control via Web browsers
- Driverless software support
- Power sequencing immunity
- Ethernet provides chassis/controller voltage isolation
- Independence from Windows operating system



## Connectivity Solutions

We provide a full range of supporting cable and connector solutions for all our switching products—20 connector families with 1200+ products. We offer everything from simple mating connectors to complex cables assemblies and terminal blocks. All assemblies are manufactured by Pickering and are guaranteed to mechanically and electrically mate to our modules.



Connectors & Backshells



Multiway Cable Assemblies

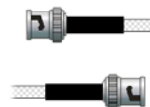

RF Cable Assemblies



Connector Blocks

We also offer customized cabling and have a free online **Cable Design Tool** that can be used to create custom cable solutions for many applications. Visit: [pickeringtest.com/cdt](http://pickeringtest.com/cdt) to start your design.



## Mass Interconnect

We recommend the use of a mass interconnect solution when an Interchangeable Test Adapter (ITA) is required for a PXI or LXI based test system. Our modules are fully supported by both Virginia Panel and MacPanel.

## Pickering Reed Relays

We are the only switch provider with in-house reed relay manufacturing capability via our Relay Division. These instrument grade reed relays feature **SoftCenter™** technology, ensuring long service life and repeatable contact performance. To learn more, please go to: [pickeringrelay.com](http://pickeringrelay.com)



## Programming

Pickering provide kernel, IVI and VISA (NI & Keysight) drivers which are compatible with all Microsoft supported versions of Windows and popular older versions. For a list of all supporting operating systems, please see: [pickeringtest.com/os](http://pickeringtest.com/os)

The VISA driver is also compatible with Real-Time Operating Systems such as LabVIEW RT. For other RTOS support contact Pickering. These drivers may be used with a variety of programming environments and applications including:

- **Pickering Interfaces Switch Path Manager**
- **National Instruments** products (LabVIEW, LabWindows/CVI, Switch Executive, MAX, TestStand, VeriStand, etc.)
- **Microsoft Visual Studio** products (Visual Basic, Visual C+)
- **Keysight** VEE and OpenTAP
- **Mathworks** Matlab
- **Marvin** ATEasy
- **MTQ Testsolutions** Tecap Test & Measurement Suite

Drivers for popular Linux distributions are available, other environments are also supported, please contact Pickering with specific enquiries. We provide Soft Front Panels (SFPs) for our products for familiarity and manual control, as well as comprehensive documentation and example programs to help you develop test routines with ease.

To learn more about software drivers and development environments, please go to: [pickeringtest.com/software](http://pickeringtest.com/software)

## Signal Routing Software

Our signal routing software, Switch Path Manager, automatically selects and energizes switch paths through Pickering switching systems. Signal routing is performed by simply defining test system endpoints to be connected together, greatly accelerating Test System software development. To learn more, please go to: [pickeringtest.com/spm](http://pickeringtest.com/spm)

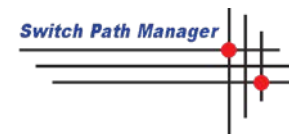

## Diagnostic Relay Test Tools

**eBIRST** Switching System Test Tools are designed specifically for our PXI, PCI or LXI products, these tools simplify switching system fault-finding by quickly testing the system and graphically identifying the faulty relay.

To learn more, please go to: [pickeringtest.com/ebirst](http://pickeringtest.com/ebirst)



## Three Year Warranty & Guaranteed Long-Term Support

All standard products manufactured by Pickering Interfaces are warranted against defective materials and workmanship for a period of three years from the date of delivery to the original purchaser. Extended warranty and service agreements are available for all our modules and systems with various levels to suit your requirements. Although we offer a 3-year warranty as standard, we also include guaranteed long-term support—with a history of supporting our products for typically 15-20 years. To learn more, please go to: [pickeringtest.com/support](http://pickeringtest.com/support)

## Available Product Resources

We have a large library of product resources including success stories, product and support videos, articles and white papers as well as application specific product brochures to assist when looking for the switching, simulation and connection solutions you need. We have also published handy reference books on Switching Technology and for the PXI and LXI standards.



To view, download or request any of our product resources, please visit: [pickeringtest.com/resources](http://pickeringtest.com/resources)