

- High Density Multiplexer With Multiple Configuration Options
- Wide Range of Sizes up to 6-Channel/160-Pole, 12-Channel/80-Pole, 24-Channel/40-Pole, 48-Channel/20-Pole, & 96-Channel/10-Pole
- Scalable (up to 6 relay cards)
- Expandable Via Common Loop-Thru Connector With Isolation Switching for Optimal Signal Integrity in Larger Systems
- Maximum Switch Current of 1A
- Switch up to 100V and up to 60W Max Power
- VISA, IVI & Kernel Drivers Supplied for Windows
- Supported by PXI or LXI Chassis
- 3 Year Warranty



The 40-570 is a High Density Multiplexer designed to simplify the connection of a common set of test equipment to one of a number of different devices for testing. It is ideal for applications where the equipment needs to conduct the same test process on a series of similar devices one at a time. It is available in a variety of configurations that allow testing with differing number of devices to be tested and different connection widths to suit differing test equipment pin counts.

The 40-570 multiplexers allow multiple channels to be simultaneously selected. Alternatively, product variants can be supplied that operate as a conventional multiplexer with break-before-make action when a new channel is selected. All versions of the 40-570 are supported in a BRIC8 format that occupies 8 PXI 3U mechanical slots, one of which provides the PXI interface and power.

MUX size can be ordered with different widths (pole counts) and with different numbers of relay cards to support varying number of devices to be tested. For example, the fully populated 40-570 can be ordered in configurations that support:

- 6 test devices with 160 connections
- 12 test devices with 80 connections
- 24 test devices with 40 connections
- 48 test devices with 20 connections
- 96 test devices with 10 connections

The pin layout of user connection is arranged to simplify the cabling design. All versions use high quality electro-mechanical relays with palladium-ruthenium gold covered contacts.

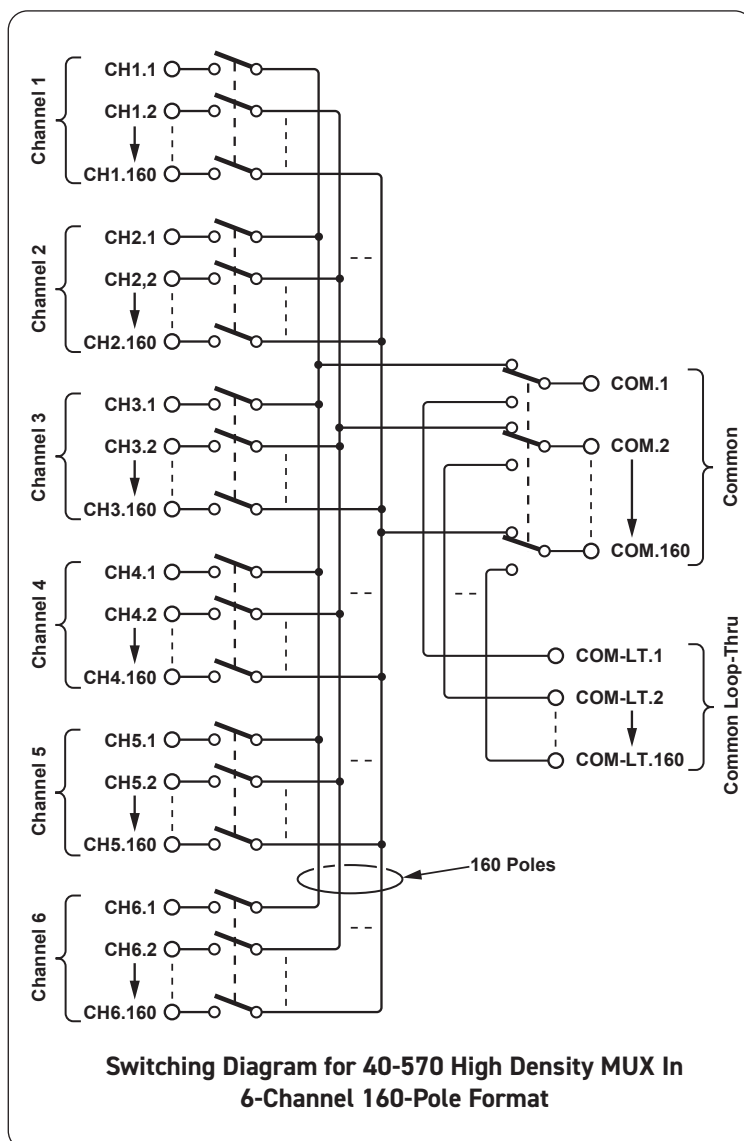

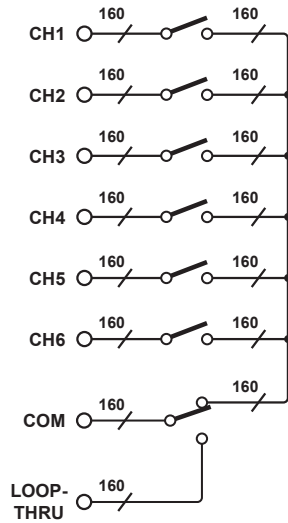

6-Channel, 160-pole Multiplexer

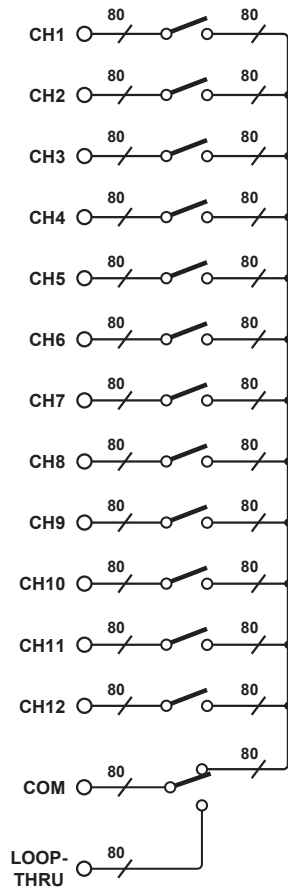

12-Channel, 80-pole Multiplexer

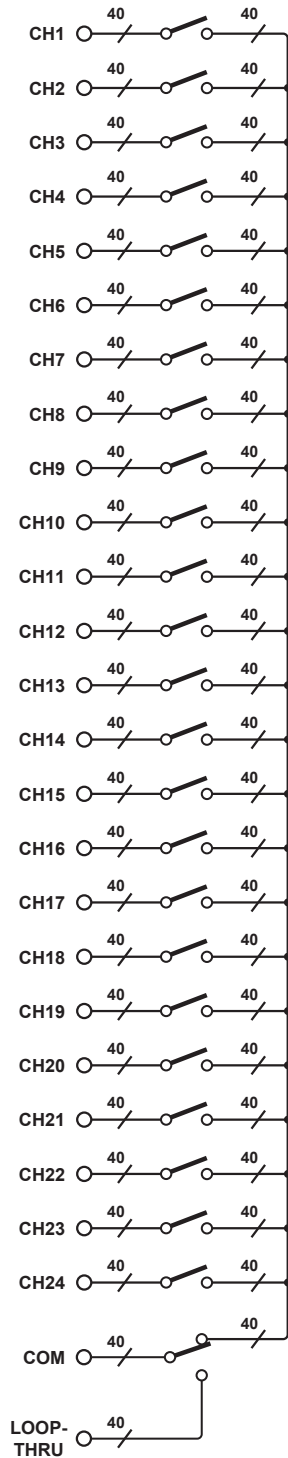

24-Channel, 40-pole Multiplexer

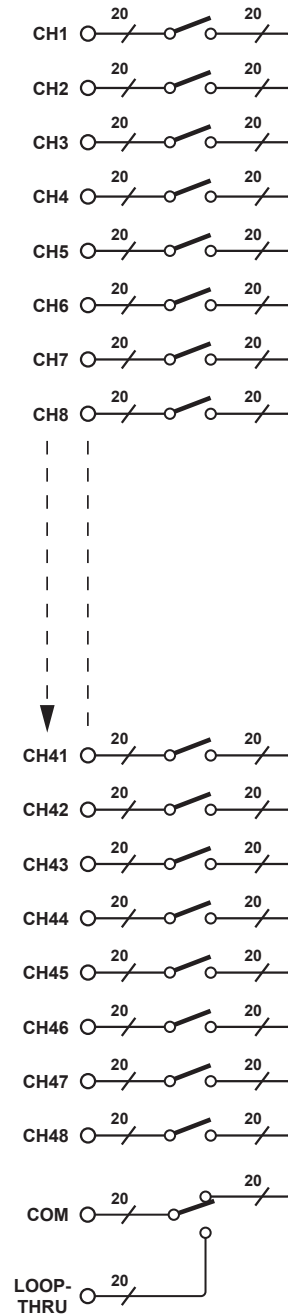

48-Channel, 20-pole Multiplexer

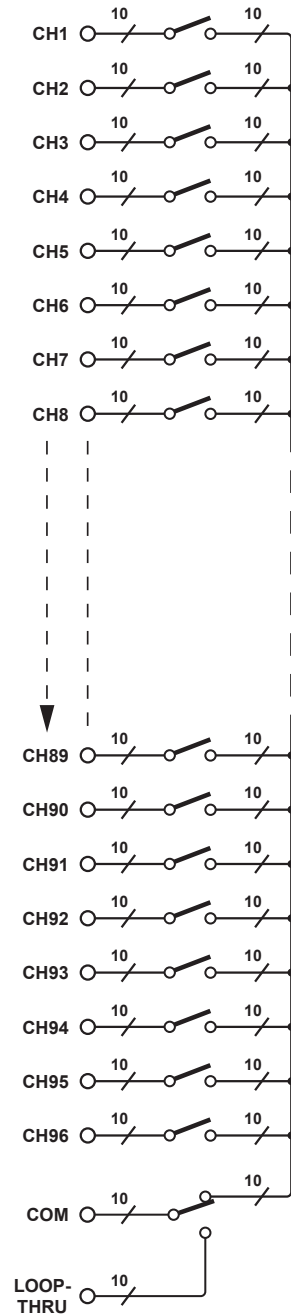

96-Channel, 10-pole Multiplexer

Switching Diagrams for the Five Possible Fully Populated Switching Configurations Available for the 40-570 High Density BRIC Multiplexer

Relay Type

The 40-570 modules are fitted with high quality electro-mechanical relays with palladium-ruthenium gold covered contacts.

Switching Specification

Switch Type:	Electro-mechanical
Contact Type:	Palladium-Ruthenium, Gold Covered Bifurcated
Max Switch Voltage:	100V*
Max Hot Switch Contact Power:	60W
Max Switch Current:	1A
Max Carry Current:	1A
Max Combined Switch Path Loading:	25W continuous power (for example: 160 x 395mA per path, 80 x 559mA per path, 40 x 791mA per path, or 25 x 1A per path)
Initial On Path Resistance:	<1Ω
Off Path Resistance:	>10 ⁹ Ω
Operate Time:	6ms typical, 3ms for multichannel mode
Expected Life (operations)	
Very low power signal load:	>1x10 ⁸
Low power load (2W):	>1.5x10 ⁷ (0.1A 20VDC)
Medium power load (30W):	>5x10 ⁶ (1A 30VDC)
Full power load (60W):	>1x10 ⁵ (1A 60VDC)
Bandwidth - 40-570-116 (50Ω system):	3dB insertion loss @ 12MHz, -20dB crosstalk @ 2.5MHz, please contact sales office for advice concerning other configurations

* For full voltage rating, signal sources to be switched must be fully isolated from mains supply and safety earth.

Power Requirements

+3.3V	+5V	+12V	-12V
100mA	6A max	0	0

Mechanical Characteristics

Eight slot 3U PXI (CompactPCI card).
3D models for all versions in a variety of popular file formats are available on request.

Connectors

PXI bus via 32-bit P1/J1 backplane connector.
Signals via multiple front panel 160-pin male DIN 41612 connectors (Up to 8 per module), for pin outs please refer to the operating manual.

Note: We recommend that Pickering mating connectors are used with this module which are designed to ensure there are no mechanical interference problems when used in a PXI chassis.

Operating/Storage Conditions

Operating Conditions

Operating Temperature:	0°C to +55°C
Humidity:	Up to 90% non-condensing
Altitude:	5000m

Storage and Transport Conditions

Storage Temperature:	-20°C to +75°C
Humidity:	Up to 90% non-condensing
Altitude:	15000m

PXI & CompactPCI Compliance

The module is compliant with the PXI Specification 2.2. Local Bus, Trigger Bus and Star Trigger are not implemented.

Uses a 33MHz 32-bit backplane interface.

Safety & CE Compliance

All modules are fully CE compliant and meet applicable EU directives: Low-voltage safety EN61010-1:2010, EMC Immunity EN61326-1:2013, Emissions EN55011:2009+A1:2010.

Product Order Codes - High Density MUX BRIC

Channel Selection	Model Variant	Order Code
Multiple	2-Channel, 160-Pole	40-570-012
Multiple	3-Channel, 160-Pole	40-570-013
Multiple	4-Channel, 160-Pole	40-570-014
Multiple	5-Channel, 160-Pole	40-570-015
Multiple	6-Channel, 160-Pole	40-570-016
Multiple	2-Channel, 80-Pole	40-570-111
Multiple	4-Channel, 80-Pole	40-570-112
Multiple	6-Channel, 80-Pole	40-570-113
Multiple	8-Channel, 80-Pole	40-570-114
Multiple	10-Channel, 80-Pole	40-570-115
Multiple	12-Channel, 80-Pole	40-570-116
Multiple	4-Channel, 40-Pole	40-570-211
Multiple	8-Channel, 40-Pole	40-570-212
Multiple	12-Channel, 40-Pole	40-570-213
Multiple	16-Channel, 40-Pole	40-570-214
Multiple	20-Channel, 40-Pole	40-570-215
Multiple	24-Channel, 40-Pole	40-570-216
Multiple	8-Channel, 20-Pole	40-570-311
Multiple	16-Channel, 20-Pole	40-570-312
Multiple	24-Channel, 20-Pole	40-570-313
Multiple	32-Channel, 20-Pole	40-570-314
Multiple	40-Channel, 20-Pole	40-570-315
Multiple	48-Channel, 20-Pole	40-570-316
Multiple	16-Channel, 10-Pole	40-570-411
Multiple	32-Channel, 10-Pole	40-570-412
Multiple	48-Channel, 10-Pole	40-570-413
Multiple	64-Channel, 10-Pole	40-570-414
Multiple	80-Channel, 10-Pole	40-570-415
Multiple	96-Channel, 10-Pole	40-570-416

Note: Contact factory if the above modules are required in single channel selection mode.

Note: Configurations can be altered on a return to the factory basis, please contact Pickering sales office for details.

For the expansion of an existing BRIC multiplexer or replacement of faulty BRIC daughter cards please contact your local sales office.

Mating Connectors & Cabling

For connection accessories for the 40-570 modules please refer to the [90-001D](#) 160-pin DIN 41612 Connector Accessories data sheet where a complete list and documentation can be found for accessories, or refer to the Connection Solutions catalog.

Product Customization

Pickering PXI modules are designed and manufactured on our own flexible manufacturing lines, giving complete product control and enabling simple customization to meet very specific requirements.

Customization can include:

- Alternative relay types
- Mixture of relay types
- Alternative number of relays
- Different performance specifications

All customized products are given a unique part number, fully documented and may be ordered at any time in the future. Please contact your local sales office to discuss.

Chassis Compatibility

This PXI module must be used in a suitable chassis. It is compatible with the following chassis types:

- All chassis conforming to the 3U PXI and 3U Compact PCI (cPCI) specification
- Legacy and Hybrid Peripheral slots in a 3U PXI Express (PXIe) chassis
- Pickering Interfaces LXI or LXI/USB Modular Chassis

Chassis Selection Guide

Standard PXI or hybrid PXIe Chassis from any Vendor:

- Mix our 1000+ PXI switching & simulation modules with any vendor's PXI instrumentation
- Embedded or remote Windows PC control
- Real-time Operating System Support
- High data bandwidths, especially with PXI Express
- Integrated module timing and synchronization

Pickering LXI or LXI/USB Modular Chassis—only accept our 1000+ PXI Switching & Simulation Modules:

- Ethernet or USB control enables remote operation
- Low-cost control from practically any controller
- LXI provides manual control via Web browsers
- Driverless software support
- Power sequencing immunity
- Ethernet provides chassis/controller voltage isolation
- Independence from Windows operating system



Connectivity Solutions

We provide a full range of supporting cable and connector solutions for all our switching products—20 connector families with 1200+ products. We offer everything from simple mating connectors to complex cables assemblies and terminal blocks. All assemblies are manufactured by Pickering and are guaranteed to mechanically and electrically mate to our modules.



Connectors & Backshells



Multiwire Cable Assemblies

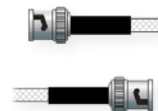

RF Cable Assemblies



Connector Blocks

We also offer customized cabling and have a free online **Cable Design Tool** that can be used to create custom cable solutions for many applications.

Visit: pickeringtest.com/cdt to start your design.

Mass Interconnect

We recommend the use of a mass interconnect solution when an Interchangeable Test Adapter (ITA) is required for a PXI or LXI based test system. Our modules are fully supported by both Virginia Panel and MacPanel.

Pickering Reed Relays

We are the only switch provider with in-house reed relay manufacturing capability via our sister company, Pickering Electronics. These instrument grade reed relays feature **SoftCenter®** technology, ensuring long service life and repeatable contact performance.

To learn more, please go to: pickeringrelay.com



Programming

Pickering provide kernel, IVI and VISA (NI & Keysight) drivers which are compatible with all Microsoft supported versions of Windows and popular older versions. For a list of all supporting operating systems, please see: pickeringtest.com/os

The VISA driver is also compatible with Real-Time Operating Systems such as LabVIEW RT. For other RTOS support contact Pickering. These drivers may be used with a variety of programming environments and applications including:

- **Pickering Interfaces Switch Path Manager**
- **National Instruments** products (LabVIEW, LabWindows/CVI, Switch Executive, MAX, TestStand, VeriStand, etc.)
- **Microsoft Visual Studio** products (Visual Basic, Visual C+)
- **Keysight** VEE and OpenTAP
- **Mathworks** Matlab
- **Marvin** ATEasy
- **MTQ Testsolutions** Tecap Test & Measurement Suite

Drivers for popular Linux distributions are available, other environments are also supported, please contact Pickering with specific enquiries. We provide Soft Front Panels (SFPs) for our products for familiarity and manual control, as well as comprehensive documentation and example programs to help you develop test routines with ease.

To learn more about software drivers and development environments, please go to:

pickeringtest.com/software

Signal Routing Software

Our signal routing software, Switch Path Manager, automatically selects and energizes switch paths through Pickering switching systems. Signal routing is performed by simply defining test system endpoints to be connected together, greatly accelerating Test System software development. To learn more, please go to: pickeringtest.com/spm



Diagnostic Relay Test Tools

eBIRST Switching System Test Tools are designed specifically for our PXI, PCI or LXI products, these tools simplify switching system fault-finding by quickly testing the system and graphically identifying the faulty relay.

To learn more, please go to: pickeringtest.com/ebirst



Three Year Warranty & Guaranteed Long-Term Support

All standard products manufactured by Pickering Interfaces are warranted against defective materials and workmanship for a period of three years from the date of delivery to the original purchaser. Extended warranty and service agreements are available for all our modules and systems with various levels to suit your requirements. Although we offer a 3-year warranty as standard, we also include guaranteed long-term support—with a history of supporting our products for typically 15-20 years. To learn more, please go to: pickeringtest.com/support

Available Product Resources

We have a large library of product resources including success stories, product and support videos, articles, as well as complete product catalogs and product reference maps to assist when looking for the switching, simulation and cable and connector solutions you need. We have also published handy reference books on Switching Technology and for the PXI and LXI standards.

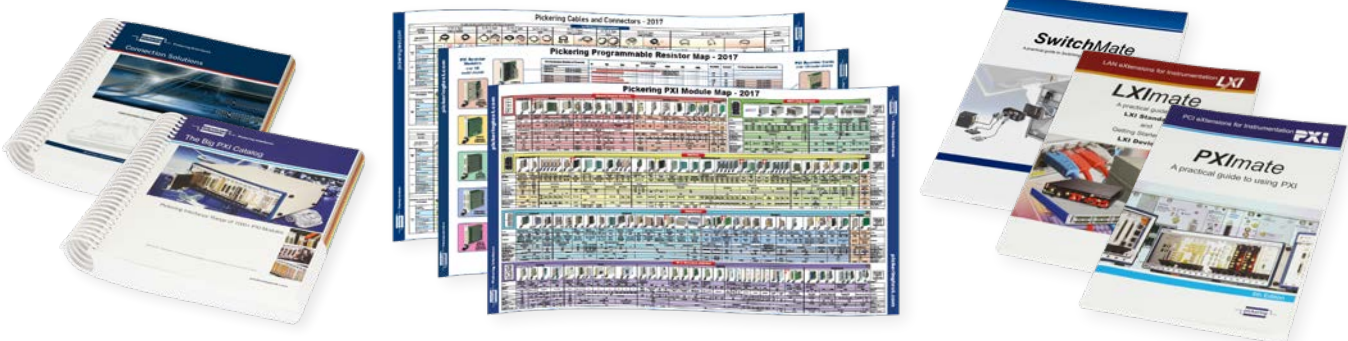

To view, download or request any of our product resources, please visit: pickeringtest.com/resources