

- R.F. Multiplexer with 2 GHz Bandwidth
- 50 Ω and 75 Ω Versions Available
- Available as 8 to 1 or Single/Dual 4 to 1
- Single 4 to 1 Version Available With Automatic Termination of Non-Selected Channels
- Choice of Front Panel Mounted Coaxial Connectors
- 75 Ω Version Suitable for Telecoms and High Quality Video Switching
- VISA, IVI & Kernel Drivers Supplied for Windows
- Supported by PXI or LXI Chassis
- 3 Year Warranty

40-740-xx1 is a range of bi-directional RF multiplexers with bandwidth beyond 2000 MHz.

They are configured as single 8:1, dual 4:1 or single 4:1, all with excellent insertion loss, VSWR and isolation. 50 Ω and 75 Ω versions are available with a wide choice of connectors:

- 40-740 Single 4 to 1 RF Multiplexer with automatic termination of all non-selected signals.
- 40-745 Single 8 to 1 or 4 to 1 RF Multiplexer (no termination option).
- 40-746 Dual 4 to 1 RF Multiplexer (no termination option).

Applications for the 40-740-xx1 include routing high frequency signals to and from oscilloscopes, analyzers, signal generators and synthesizers, telecoms tributary switching (from 2 MBit/s to 155 MBit/s), video/audio switching and switching high frequency logic signals.

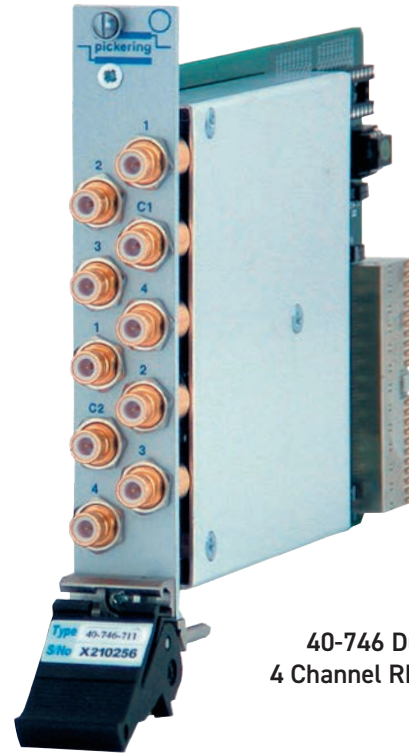

40-746 Dual 4 Channel RF MUX

40-740 Single 4 Channel RF MUX, BNC Version

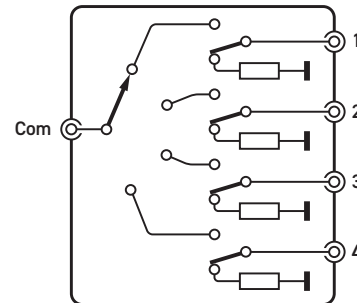

40-740 Single 4 Channel Multiplexer With Automatic Termination of Non-Selected Channels

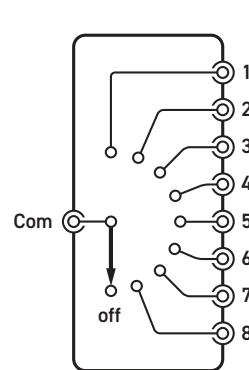

40-745 Single 8 Channel Multiplexer

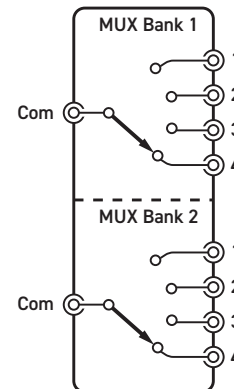

40-746 Dual 4 Channel Multiplexer (dual channel mode has no off state)

Relay Type

The 40-740/745/746 are fitted with high reliability RF Relays, these offer long life with good low level switching performance. A spare RF relay is built onto the circuit board to allow easy maintenance with minimum downtime.

General Specification (All Versions)

Maximum Voltage:	50 VDC
Maximum Power:	10 W
Maximum Carry Power (900MHz):	15 W
Maximum Switch Current:	0.1 A
Initial On Path Resistance:	<500 mΩ
Off Path Resistance:	>10 ⁸ Ω
Thermal Offset:	<20 μV
Expected Life, Mechanical:	>1x10 ⁶ operations
Expected Life, Electrical (low power):	>3x10 ⁵ operations
Expected Life, Electrical (max power):	>3x10 ⁵ operations
Switching Time:	5 ms

Isolation and Crosstalk Specification

Isolation (0 to 2000 MHz):	>20 dB
Crosstalk (0 to 2000 MHz):	>20 dB

50 Ω Specification (except BNC version)

Maximum Frequency:	2000 MHz
Rise Time:	<0.2 ns
Insertion Loss:	<3 dB
VSWR (0 to 2000MHz):	<1:1.9

75 Ω Specification (except BNC version)

Maximum Frequency:	2000 MHz
Rise Time:	<0.3 ns
Insertion Loss:	<3 dB
VSWR (0 to 1000MHz):	<1:1.8

75 Ω Specification (50 Ω & 75 Ω BNC versions)

Maximum Frequency:	1000 MHz
--------------------	----------

Power Requirements

+3.3V	+5V	+12V	-12V
0	320 mA (typ 240 mA)	0	0

Mechanical Characteristics

Single slot 3U PXI (CompactPCI card).

Module weight: 220 g (40-746-731).

3D models for all versions in a variety of popular file formats are available on request.

Connectors

PXI bus via 32-bit P1/J1 backplane connector.

Signals via front panel coaxial connectors:

- 40-740-711 - 5 x SMZ/Type43 75 Ω
- 40-740-731 - 5 x 1.0/2.3 75 Ω
- 40-740-751 - 5 x SMB 75 Ω
- 40-745-501 - 5 x BNC 50 Ω
- 40-745-591 - 5 x SMB 50 Ω
- 40-745-701 - 5 x BNC 75 Ω
- 40-745-711 - 9 x SMZ/Type43 75 Ω
- 40-745-731 - 9 x 1.0/2.3 75 Ω
- 40-745-751 - 9 x SMB 75 Ω
- 40-746-711 - 10 x SMZ/Type43 75 Ω
- 40-746-731 - 10 x 1.0/2.3 75 Ω
- 40-746-751 - 10 x SMB 75 Ω

Operating/Storage Conditions

Operating Conditions

Operating Temperature:	0 °C to +55 °C
Humidity:	Up to 90% non-condensing
Altitude:	5000 m

Storage and Transport Conditions

Storage Temperature:	-20 °C to +75 °C
Humidity:	Up to 90% non-condensing
Altitude:	15000 m

PXI & CompactPCI Compliance

The module is compliant with the PXI Specification 2.2.

Local Bus, Trigger Bus & Star Trigger are not implemented.

Uses a 33 MHz 32-bit backplane interface.

Safety & CE Compliance

All modules are fully CE compliant and meet applicable

EU directives: Low-voltage safety EN61010-1:2010,

EMC Immunity EN61326-1:2013,

Emissions EN55011:2009+A1:2010.

Product Order Codes

4 to 1 RF Multiplexer with Automatic Termination

75 Ω, SMZ/Type 43 Connector, 2 GHz	40-740-711
75 Ω, Siemens 1.0/2.3 Connector, 2 GHz	40-740-731
75 Ω, SMB Connector, 2 GHz	40-740-751

4 to 1 RF Multiplexer

50 Ω, BNC Connector, 1 GHz	40-745-501
50 Ω, SMB Connector, 2 GHz	40-745-591
75 Ω, BNC Connector, 1 GHz	40-745-701

8 to 1 RF Multiplexer

75 Ω, SMZ/Type 43 Connector, 2 GHz	40-745-711
75 Ω, Siemens 1.0/2.3 Connector, 2 GHz	40-745-731
75 Ω, SMB Connector, 2 GHz	40-745-751

Dual 4 to 1 RF Multiplexer

75 Ω, SMZ/Type 43 Connector, 2 GHz	40-746-711
75 Ω, Siemens 1.0/2.3 Connector, 2 GHz	40-746-731
75 Ω, SMB Connector, 2 GHz	40-746-751

-C Alternative connectors may be available, please consult factory

Product Customization

Pickering modules are designed and manufactured on our own flexible manufacturing lines, giving complete product control and enabling simple customization to meet very specific requirements.

All customized products are given a unique part number, fully documented and may be ordered at any time in the future. Please contact your local sales office to discuss.

Support Products

Spare Relay Kits

Kits of replacement relays are available for the majority of Pickering's switching products, simplifying servicing and reducing down-time.

Product	Relay Kit
40-740-711/731/751	91-100-029
40-745-501/591	91-100-096
40-745-701/711/731/751	91-100-029
40-746-711/731/751	91-100-029

For further assistance, please contact your local Pickering sales office.

Mating Connectors & Cabling

For connection accessories for the 40-740-xx1 series please refer to the [90-011D](#) RF Cable Assemblies data sheet where a complete list and documentation can be found for accessories, or refer to the Connection Solutions catalog.

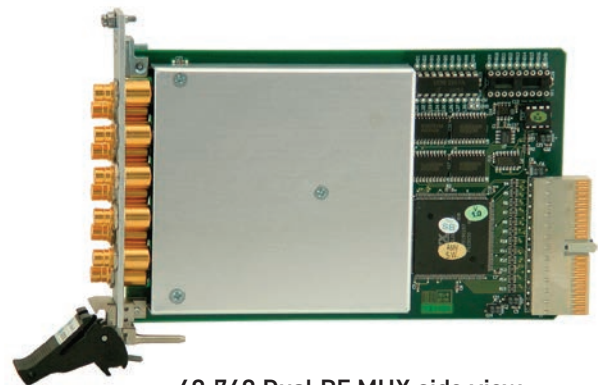

40-740 Dual RF MUX side view

Chassis Compatibility

This PXI module must be used in a suitable chassis. It is compatible with the following chassis types:

- All chassis conforming to the 3U PXI and 3U Compact PCI (cPCI) specification
- Legacy and Hybrid Peripheral slots in a 3U PXI Express (PXIe) chassis
- Pickering Interfaces LXI or LXI/USB Modular Chassis

Chassis Selection Guide

Standard PXI or hybrid PXIe Chassis from any Vendor:

- Mix our 1000+ PXI switching & simulation modules with any vendor's PXI instrumentation
- Embedded or remote Windows PC control
- Real-time Operating System Support
- High data bandwidths, especially with PXI Express
- Integrated module timing and synchronization



Pickering LXI or LXI/USB Modular Chassis—only accept our 1000+ PXI Switching & Simulation Modules:

- Ethernet or USB control enables remote operation
- Low-cost control from practically any controller
- LXI provides manual control via Web browsers
- Driverless software support
- Power sequencing immunity
- Ethernet provides chassis/controller voltage isolation
- Independence from Windows operating system



Connectivity Solutions

We provide a full range of supporting cable and connector solutions for all our switching products—20 connector families with 1200+ products. We offer everything from simple mating connectors to complex cables assemblies and terminal blocks. All assemblies are manufactured by Pickering and are guaranteed to mechanically and electrically mate to our modules.



Connectors & Backshells



Multiwire Cable Assemblies

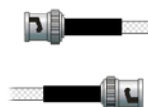

RF Cable Assemblies



Connector Blocks

We also offer customized cabling and have a free online **Cable Design Tool** that can be used to create custom cable solutions for many applications. Visit: pickeringtest.com/cdt to start your design.

Mass Interconnect

We recommend the use of a mass interconnect solution when an Interchangeable Test Adapter (ITA) is required for a PXI or LXI based test system. Our modules are fully supported by both Virginia Panel and MacPanel.



Pickering Reed Relays

We are the only switch provider with in-house reed relay manufacturing capability via our Relay Division. These instrument grade reed relays feature **SoftCenter™** technology, ensuring long service life and repeatable contact performance. To learn more, please go to: pickeringrelay.com



Programming

Pickering provide kernel, IVI and VISA (NI & Keysight) drivers which are compatible with all Microsoft supported versions of Windows and popular older versions. For a list of all supporting operating systems, please see: pickeringtest.com/os

The VISA driver is also compatible with Real-Time Operating Systems such as LabVIEW RT. For other RTOS support contact Pickering. These drivers may be used with a variety of programming environments and applications including:

- **Pickering Interfaces Switch Path Manager**
- **National Instruments** products (LabVIEW, LabWindows/CVI, Switch Executive, MAX, TestStand, VeriStand, etc.)
- **Microsoft Visual Studio** products (Visual Basic, Visual C+)
- **Keysight** VEE and OpenTAP
- **Mathworks** Matlab
- **Marvin** ATEasy
- **MTQ Testsolutions** Tecap Test & Measurement Suite

Drivers for popular Linux distributions are available, other environments are also supported, please contact Pickering with specific enquiries. We provide Soft Front Panels (SFPs) for our products for familiarity and manual control, as well as comprehensive documentation and example programs to help you develop test routines with ease.

To learn more about software drivers and development environments, please go to: pickeringtest.com/software

Signal Routing Software

Our signal routing software, Switch Path Manager, automatically selects and energizes switch paths through Pickering switching systems. Signal routing is performed by simply defining test system endpoints to be connected together, greatly accelerating Test System software development. To learn more, please go to: pickeringtest.com/spm

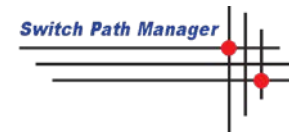

Diagnostic Relay Test Tools

eBIRST Switching System Test Tools are designed specifically for our PXI, PCI or LXI products, these tools simplify switching system fault-finding by quickly testing the system and graphically identifying the faulty relay.

To learn more, please go to: pickeringtest.com/ebirst



Three Year Warranty & Guaranteed Long-Term Support

All standard products manufactured by Pickering Interfaces are warranted against defective materials and workmanship for a period of three years from the date of delivery to the original purchaser. Extended warranty and service agreements are available for all our modules and systems with various levels to suit your requirements. Although we offer a 3-year warranty as standard, we also include guaranteed long-term support—with a history of supporting our products for typically 15-20 years. To learn more, please go to: pickeringtest.com/support

Available Product Resources

We have a large library of product resources including success stories, product and support videos, articles and white papers as well as application specific product brochures to assist when looking for the switching, simulation and connection solutions you need. We have also published handy reference books on Switching Technology and for the PXI and LXI standards.



To view, download or request any of our product resources, please visit: pickeringtest.com/resources