



- Double Pole High Density Matrix - Up To 4096 Crosspoints
- Dual Analog Bus
- Matrix Size 192x8 to 512x8 (60-555)
- Matrix Size 192x4 to 512x4 (60-556)
- Uses High Quality Electro-Mechanical Relays
- Switch up to 300VDC/250VAC & up to 60W Max Power

- Maximum Switch Current of 2A
- 1U Rack Mountable Enclosure
- LXI Standard 1.4 Compliant
- IVI & Direct I/O Drivers
- Supported by *BIRST*™ & *eBIRST*™ Test Tools
- 3 Year Warranty

The 60-555 is a high density double pole 512x8 matrix suitable for signal routing in large ATE systems. It is easily expanded to produce larger sizes, for example, two units can be linked to create a 1024x8 matrix. The 60-556 has an identical architecture to the 60-555 but has a 4-way instead of an 8-way Y-bus.

The matrix is constructed from 64x8 or 64x4 sub assemblies, allowing it to be supplied in sizes from 192 to 512 X connections in increments of 64.

Dual Analog Bus

The Y axis of each 64x8 sub-matrix can be connected to one of two analog buses (Dual Analog Bus). These can be used to maximize bandwidth by disconnecting unused stub matrices from the bus in use. They also provide configuration flexibility by giving the potential to divide the 60-555/556 into two independent matrices whose size can be set in increments of 64 X connections.

The 60-555/556 is designed in accordance with the LXI Standard 1.4 and is supplied in a 1U high, full rack width case with 500mm

depth. It is programmable via the LAN interface using Pickering's generic switch driver. Standard (W3C) web browsers can be used to change the configuration and access the soft front panels.

The 60-555/556 is ideal for situations where a simple start-up is required and for applications requiring control over large distances.

Built-In Relay Self-Test - *BIRST*

The *BIRST* facility provides a quick and easy way of finding relay failures. No test equipment is required, simply un-plug the connectors, launch the *BIRST* application and the tool will run a diagnostic test that will find all relays with faulty contacts.

For more information go to: pickeringtest.com/birst

Supported by *eBIRST*

This matrix is also supported by *eBIRST*. These tools simplify switching system fault-finding by quickly testing the system and graphically identifying the faulty relay.

For more information go to: pickeringtest.com/ebirst

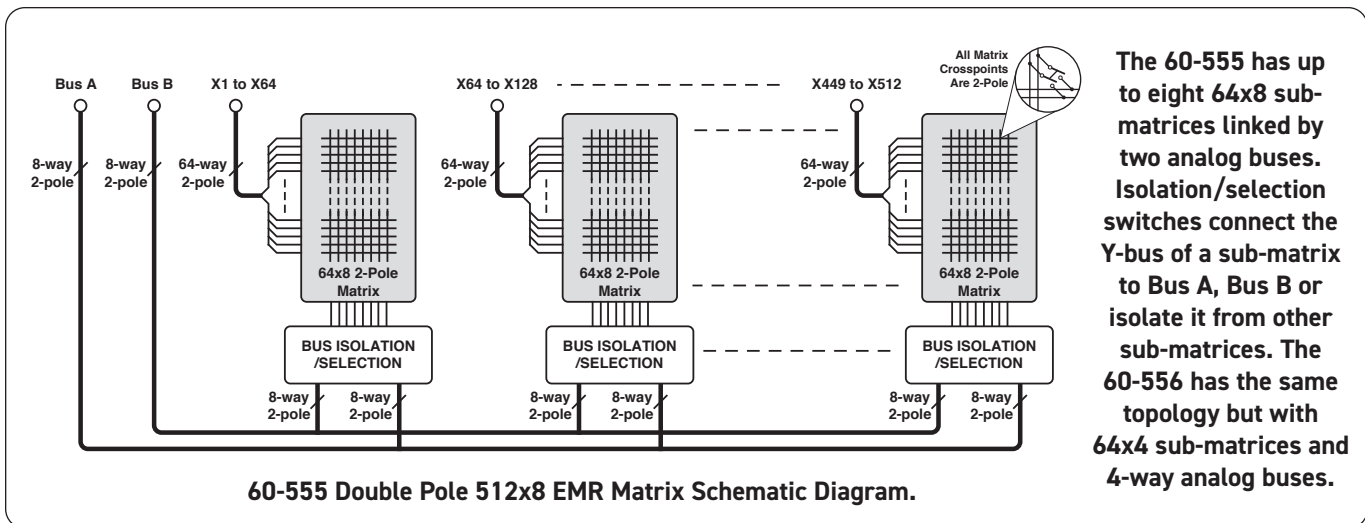

The 60-555 has up to eight 64x8 sub-matrices linked by two analog buses. Isolation/selection switches connect the Y-bus of a sub-matrix to Bus A, Bus B or isolate it from other sub-matrices. The 60-556 has the same topology but with 64x4 sub-matrices and 4-way analog buses.

Matrix Expansion

The 60-555/556 may be expanded to larger matrix sizes by using cabling to daisy-chain the Y signals.

The illustrations below show four 60-555-008 512x8 2-pole matrices interconnected as a 2048x8 2-pole matrix using specially constructed cables. The first diagram shows the matrix schematic and the second diagram shows how the front panel connectors are cabled together.

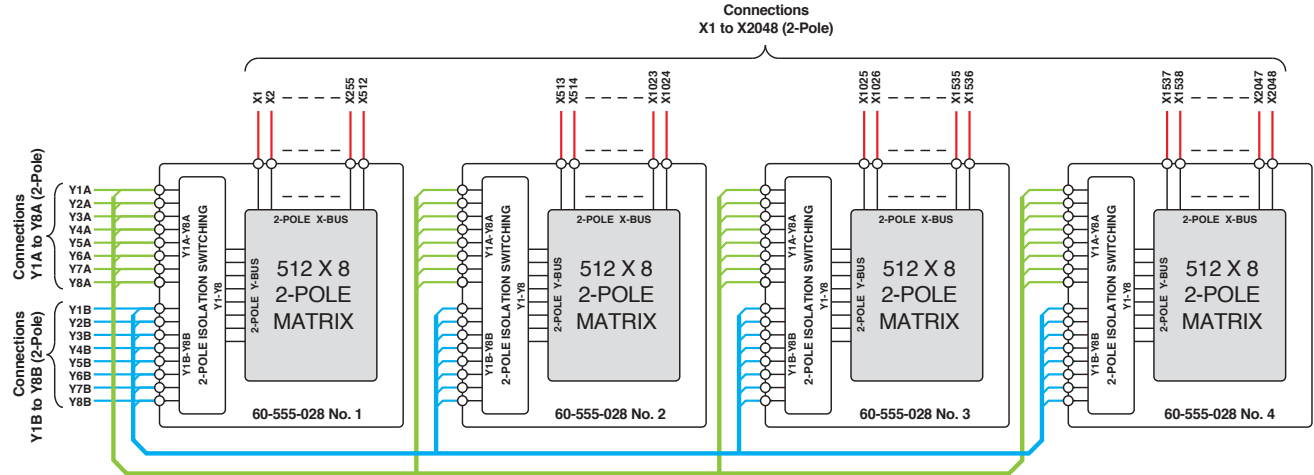

Schematic Diagram of four 60-555-028 matrices connected as a single 2048x8 2-pole matrix, the 60-555 is fitted with Dual 8-wire, 2-pole Analog Buses

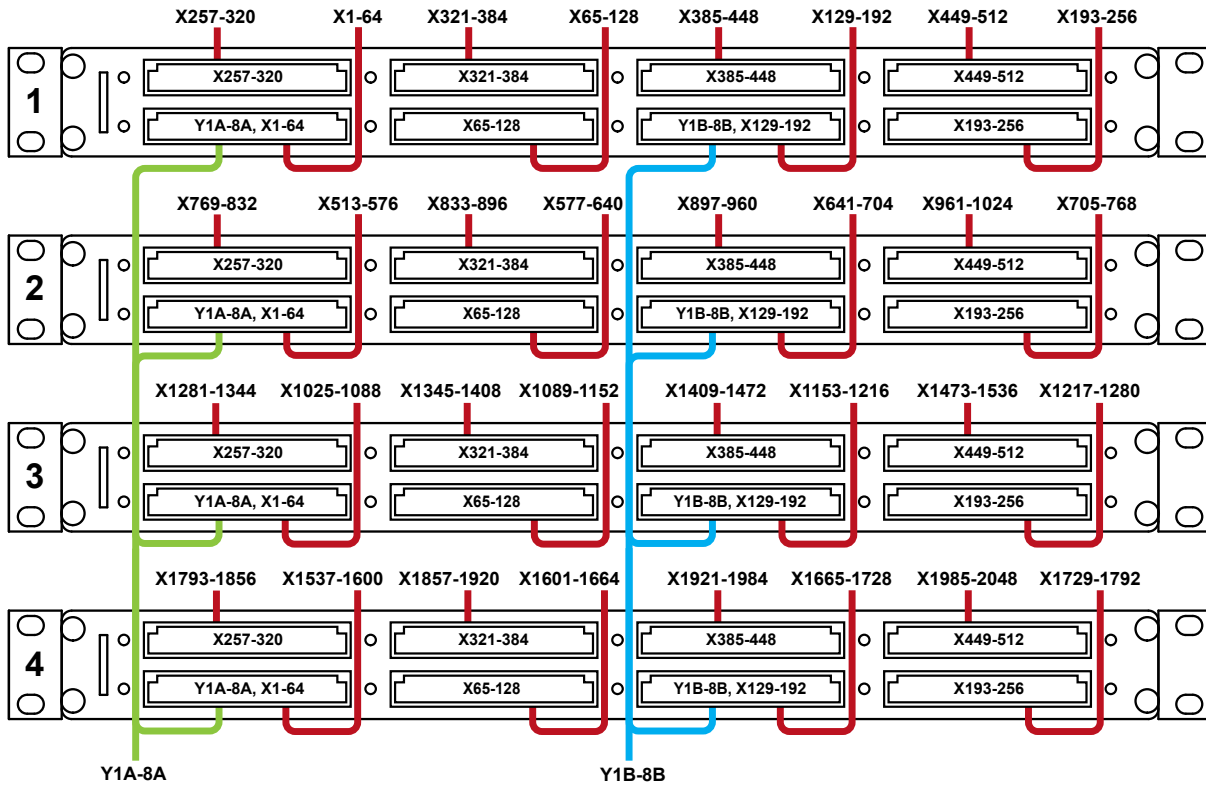

Diagram showing the front panel cabling required to interconnect four 60-555-028 matrices as a single 2048x8 2-pole matrix

Relay Type

The 60-555/556 is fitted with high quality electro-mechanical relays. These relays are leaded types (not surface mount) so field maintenance is greatly simplified. Spare relays are built onto the circuit board to allow easy maintenance with minimum downtime.

Switching Specification

Switch Type	Electro-mechanical
Contact Type:	Palladium-Ruthenium, Gold Covered Bifurcated
Max Switch Voltage:	300VDC/250VAC*
Max Power:	62.5VA, 60W from 30V to 220VDC, 30W to 300VDC (resistive load)
Max Switch Current:	2A
Max Continuous Carry Current:	2A
Max Pulsed Carry Current	
Example (for a single switch path):	6A for 100ms (up to 10% duty cycle)
Initial Path Resistance - On:	1Ω typical (highest resistance path)
Initial Path Resistance - Off:	>10 ⁹ Ω
Minimum Voltage:	100μV
Differential Thermal Offset:	<2μV
Operate Times	
Crosspoint Relay:	<3ms
Crosspoint + Isolation Relay:	<6ms
Expected Life (operations)	
Very low power signal load:	>1x10 ⁸
Low power load (2W):	>1.5x10 ⁷ (0.1A 20VDC)
Medium power load (30W):	>5x10 ⁶ (1A 30VDC)
Full power load (60W):	>1x10 ⁵ (2A 30VDC)
	>1x10 ⁵ (0.1A 300VDC)
Bandwidth:	5MHz typical (fully populated)
Crosstalk:	40dB typical at 600kHz
Max Number of simultaneously closed crosspoints:	512

* For full voltage rating, signal sources to be switched must be fully isolated from mains supply and safety earth.

Power Source

Universal AC mains supply, 90-120/200-240V 50-60Hz	
Power Inlet:	Male IEC connector
Power Rating:	100VA maximum
Fuse Rating:	(F) 5A, 250V

LAN Interface

Compliant to LXI Standard 1.4, the 60-555/556 has a 1000Base-T Ethernet Interface via a standard RJ-45 connector mounted on the rear panel with an LCD display showing the unit's IP address.*

***Note:** Legacy units may not have 1000Base-T support or be fitted with an LCD display.

Mechanical Characteristics

Supplied with front panel ears to enable rack mounting on a shelf or other rear support mechanism.

Dimensions: 1U high, full rack width, 500mm depth

3D models for all versions in a variety of popular file formats are available on request.

Connectors

Signals via front panel connectors.

X and Y connections are via 8 x160-pin DIN41612 plugs (Y connections are on the first and third X signal connectors).

For pin outs please refer to the operating manual.

Operating/Storage Conditions

Operating Conditions

Operating Temperature: 0°C to +55°C

Humidity: Up to 90% non-condensing

Altitude: 5000m

Storage and Transport Conditions

Storage Temperature: -20°C to +75°C

Humidity: Up to 90% non-condensing

Altitude: 15000m

Safety & CE Compliance

All products are fully CE compliant and meet applicable EU directives: Low-voltage safety EN61010-1:2010, EMC Immunity EN61326-1:2013, Emissions EN55011:2009+A1:2010.

Product Order Codes

LXI High Density 192x8 2-Pole EMR Matrix	60-555-023
LXI High Density 256x8 2-Pole EMR Matrix	60-555-024
LXI High Density 320x8 2-Pole EMR Matrix	60-555-025
LXI High Density 384x8 2-Pole EMR Matrix	60-555-026
LXI High Density 448x8 2-Pole EMR Matrix	60-555-027
LXI High Density 512x8 2-Pole EMR Matrix	60-555-028
LXI High Density 192x4 2-Pole EMR Matrix	60-556-023
LXI High Density 256x4 2-Pole EMR Matrix	60-556-024
LXI High Density 320x4 2-Pole EMR Matrix	60-556-025
LXI High Density 384x4 2-Pole EMR Matrix	60-556-026
LXI High Density 448x4 2-Pole EMR Matrix	60-556-027
LXI High Density 512x4 2-Pole EMR Matrix	60-556-028

Product Order Codes Without BIRST

60-555/556 is still available for users who have qualified the product without the BIRST feature:

LXI High Density 192x8 2-Pole EMR Matrix	60-555-003
LXI High Density 256x8 2-Pole EMR Matrix	60-555-004
LXI High Density 320x8 2-Pole EMR Matrix	60-555-005
LXI High Density 384x8 2-Pole EMR Matrix	60-555-006
LXI High Density 448x8 2-Pole EMR Matrix	60-555-007
LXI High Density 512x8 2-Pole EMR Matrix	60-555-008
LXI High Density 192x4 2-Pole EMR Matrix	60-556-003
LXI High Density 256x4 2-Pole EMR Matrix	60-556-004
LXI High Density 320x4 2-Pole EMR Matrix	60-556-005
LXI High Density 384x4 2-Pole EMR Matrix	60-556-006
LXI High Density 448x4 2-Pole EMR Matrix	60-556-007
LXI High Density 512x4 2-Pole EMR Matrix	60-556-008

Support Products

eBIRST Switching System Test Tool

This product is supported by the eBIRST test tools which simplify the identification of failed relays, the required eBIRST tools are below. This product requires master slave testing and one set of each tool is required together with the master slave cable 93-970-301. For more information go to: pickeringtest.com/ebirst

Product	Test Tool	Adaptor
60-555/556	93-002-001	93-002-410

Spare Relay Kits

Kits of replacement relays are available for the majority of Pickering's switching products, simplifying servicing and reducing down-time.

Product	Relay Kit
60-555/556	91-100-001

For further assistance, please contact your local Pickering sales office.

Mating Connectors & Cabling

For connection accessories for the 60-555/556 please refer to the [90-001D](#) 160-pin DIN41612 Connector Accessories data sheet where a complete list and documentation can be found for accessories, or refer to the Connection Solutions catalog.

Product Customization

Pickering LXI units are designed and manufactured on our own flexible manufacturing lines, giving complete product control and enabling simple customization to meet very specific requirements.

Customization can include:

- Alternative relay types
- Mixture of relay types
- Alternative number of relays
- Different performance specifications

All customized products are given a unique part number, fully documented and may be ordered at any time in the future. Please contact your local sales office to discuss.

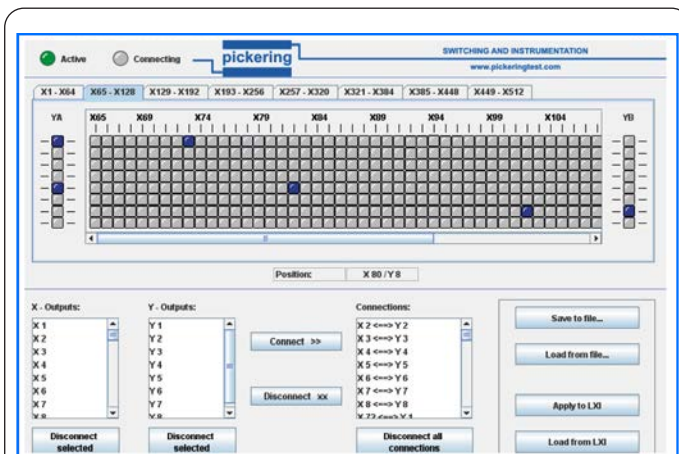

Soft Front Panel for the 60-555 Matrix - can be executed as a Java applet from the device's LXI home page and allows graphical control of the matrix

Connectivity Solutions

We provide a full range of supporting cable and connector solutions for all our switching products—20 connector families with 1200+ products. We offer everything from simple mating connectors to complex cables assemblies and terminal blocks. All assemblies are manufactured by Pickering and are guaranteed to mechanically and electrically mate to our modules.

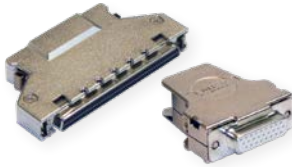

Connectors & Backshells



Multiwire Cable Assemblies

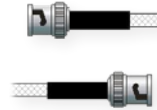

RF Cable Assemblies



Connector Blocks

We also offer customized cabling and have a free online **Cable Design Tool** that can be used to create custom cable solutions for many applications. Visit: pickeringtest.com/cdt to start your design.

Mass Interconnect

We recommend the use of a mass interconnect solution when an Interchangeable Test Adapter (ITA) is required for a PXI or LXI based test system. Our modules are fully supported by both Virginia Panel and MacPanel.

Pickering Reed Relays

We are the only switch provider with in-house reed relay manufacturing capability via our sister company, Pickering Electronics. These instrument grade reed relays feature **SoftCenter®** technology, ensuring long service life and repeatable contact performance.

To learn more, please go to: pickeringrelay.com

Programming

All LXI devices are supplied with built-in software drivers, web pages for configuration and soft front panels as required by the LXI specification. A variety of drivers are provided (C, .NET, IVI, SOAP) which are compatible with all Microsoft supported versions of Windows and popular older versions. For a list of all supporting operating systems, please see: pickeringtest.com/os

The drivers may be used in many commonly used programming environments and applications including:

- **Pickering Interfaces Switch Path Manager**
- **National Instruments** products (LabVIEW, LabWindows/CVI, Switch Executive, MAX, TestStand, VeriStand, etc.)
- **Microsoft Visual Studio** products (Visual Basic, Visual C++, Visual C#)
- **Keysight** VEE and OpenTAP
- **Mathworks** Matlab
- **Marvin** ATEasy
- **MTQ Testsolutions** Tecap Test & Measurement Suite

As well as various open source environments such as:

- **Sharp Develop**
- **Dev-C++**

To learn more about software drivers and development environments, please go to: pickeringtest.com/software



Signal Routing Software

Our signal routing software, Switch Path Manager, automatically selects and energizes switch paths through Pickering switching systems. Signal routing is performed by simply defining test system endpoints to be connected together, greatly accelerating Test System software development.

To learn more, please go to: pickeringtest.com/spm



Diagnostic Relay Test Tools

eBIRST Switching System Test Tools are designed specifically for our PXI, PCI or LXI products, these tools simplify switching system fault-finding by quickly testing the system and graphically identifying the faulty relay.

To learn more, please go to: pickeringtest.com/ebirst



Three Year Warranty

All standard products manufactured by Pickering Interfaces are warranted against defective materials and workmanship for a period of three years from the date of delivery to the original purchaser. Extended warranty and service agreements are available for all our modules and systems with various levels to suit your requirements. Although we offer a 3-year warranty as standard, we also include guaranteed long-term support—with a history of supporting our products for typically 15-20 years. To learn more, please go to: pickeringtest.com/support

Available Product Resources

We have a large library of product resources including success stories, product and support videos, articles, as well as complete product catalogs and product reference maps to assist when looking for the switching, simulation and cable and connector solutions you need. We have also published handy reference books on Switching Technology and for the PXI and LXI standards.

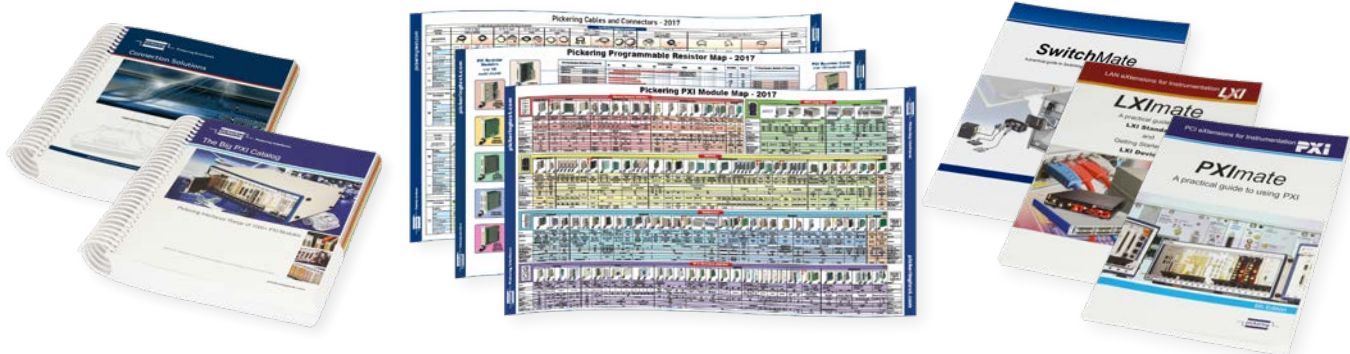

To view, download or request any of our product resources, please visit: pickeringtest.com/resources

© Copyright (2020) Pickering Interfaces. All Rights Reserved
Pickering Interfaces maintains a commitment to continuous product development, consequently we reserve the right to vary from the description given in this data sheet.